

**GENNECT Cloud
GENNECT Remote
Service Specifications**

Version 07

Created by	Hioki E.E. Corporation
Created on	December 23, 2021
Last updated on	June 27, 2024

Contents

Contents	2
0. Introduction.....	3
1. Service details and scope	3
Service overview.....	3
Products/services provided.....	4
Sample applications/orders.....	7
Service features and overview	13
Maintenance products.....	23
Service period.....	24
Service renewal.....	24
Service resumption.....	25
Service cancellation during the license term	25
Service level agreement (SLA).....	26
Service hours and availability.....	26
Operation monitoring	27
Handling a failure.....	27
Maintenance	27
Password policy	27
Security.....	27
(i) Computer virus protection	27
(ii) Unauthorized access.....	27
(iii) Interception of communications	28
(iv) Audit.....	28
Safety Control Standards	28
Backing up data	28
Restoring data.....	28
Deleting data	28
Deleting an account.....	29
Emails are not received for a long time	29
Violation of prohibitions of the Terms of Use.....	29

0. Introduction

Thank you for using our measurement cloud service, GENNECT Cloud, and remote measurement service, GENNECT Remote. The following shows the contents of the Service to be provided, usage fee, scope of provision, method of provision, level of provision, utilization time, and other terms and conditions of the measurement cloud service, GENNECT Cloud, and the remote measurement service, GENNECT Remote (henceforth called the “Services”) provided by Hioki E.E. Corporation (henceforth called the “Company”) for customers who have applied to use the Services (in this document, customers shall mean the individuals, companies, other organizations, or their representatives that have concluded a Usage Contract with the Company based on the Terms of Use and opened an account for the Services and that have the permissions of a user administrator.) The Service Specifications shall be part of the GENNECT Cloud Terms of Use and the GENNECT Remote Terms of Use. The “Terms of Use” in the Service Specifications shall refer to these terms of use.

1. Service details and scope

Service overview

The Services provide the cloud service for storing measurement data and files; the Web portal that accesses the cloud service to view and manage measurement data, files, and settings; the gateway that communicates with our GENNECT Remote-ready measurement devices owned by the customers and uploads measurement data to the cloud; and the communication lines for the gateway to communicate with the cloud (using NTT docomo’s communication network).

Thus, you can centrally manage measurement data from geographically distributed measurement devices. You can use the Services as a platform to compare data trends across locations, which was difficult in the past, and make use of analyses.

The following figure shows the scope of the Services, the scope of the Company’s responsibility for maintenance and operation after the Services are provided, and the scope of the customer’s responsibility. The GENNECT Cloud provides cloud services, a Web portal, communication lines, and a gateway (blue areas surrounded by a dotted line). After your purchase, the Company shall be responsible for the maintenance and operation of the cloud services, the Web portal, communication lines, and firmware for the gateway. The customer is responsible for the gateway hardware. The gateway cannot be repaired. In the event of a failure, the gateway will be replaced with a new one for a fee (free of charge if it is covered by warranty; for details, please see the warranty for the gateway).

*GENNECT Remote gateways and communication lines are only available in Japan.

GENNECT Cloud Service Specifications

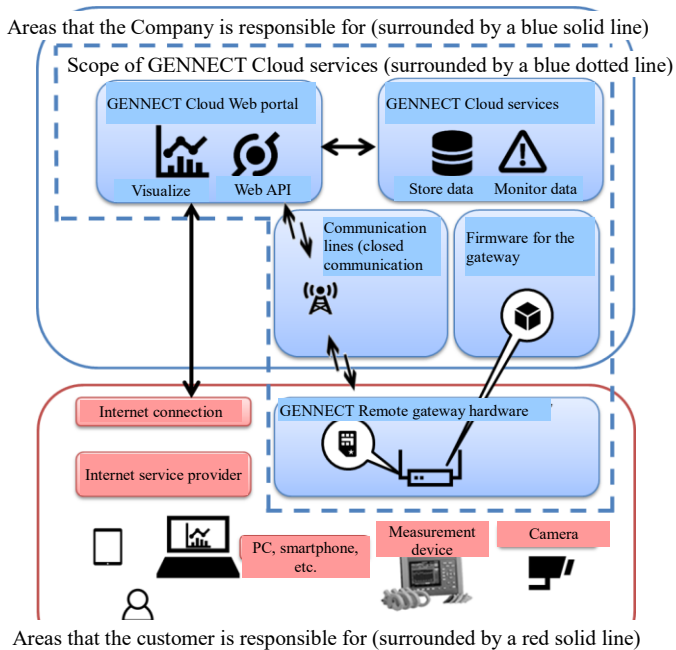

Products/services provided

This section describes the products and services provided. While your GENNECT Remote license is valid, the GENNECT Cloud Standard services are automatically provided free of charge.

Measurement cloud service SF4180 GENNECT Cloud

- Details of the plan

Plan name	GENNECT Cloud Trial	GENNECT Cloud Free	GENNECT Cloud Standard	GENNECT Cloud Pro
Account	N/A	Available	Available	Available
Storage	500 MB	5 GB	50 GB	500 GB
Number of applications	2	3	10	100
Number of users	1	3	10	100
Number of teams	0	3	10	100
Number of measurement groups	1	1	10	100
Number of alarms (for each measurement group)	1	3	30	100
Number of calculation channels (per measurement group)	0	3	30	100
Number of dashboard panels (per measurement group)	0	1	3	10
Number of channel selection (per instrument) (One)	10	30	30	100
Number of channel selection (LR8450 direct)	-	30	150	1000
Number of connectable instruments (Cross / One)	1	3	8	8
Number of template (per measurement group)	0	0	30	100
Number of battery profile	0	0	30	100

GENNECT Cloud Service Specifications

Number of battery threshold table	0	0	30	100
Number of sharing equipment List	0	0	30	100
Number of templates for automatic report output (per measurement group)	0	0	3	10
Console (in GENNECT One remote monitoring mode)	N/A	N/A	Available	Available
Console (in LR8450 direct)	N/A	Only Browse	Available	Available
Maintaining expired SIM	N/A	N/A	Available	Available
Web API	N/A	N/A	N/A	Available
IP address restriction	N/A	N/A	N/A	Available
Set your own logo	N/A	Available	Available	Available
Alternative login account ID	N/A	N/A	N/A	Available
Measured value import	N/A	N/A	N/A	Available

- License plans and prices (tax not included)

Plan name	GENNECT Cloud Trial	GENNECT Cloud Free	GENNECT Cloud Standard	GENNECT Cloud Pro
Subscription (monthly)	Free of charge	Free of charge	2,200 yen	5,500 yen
One-month license card	-	-	SF4181-01 3,300 yen	SF4182-01 16,000 yen
Three-month license card	-	-	SF4181-03 8,800 yen	SF4182-03 44,000 yen
12-month license card	-	-	SF4181-12 31,900 yen	SF4182-12 159,500 yen

Remote measurement service SF4111/SF4112 GENNECT Remote

- Details of the plan

Plan name	GENNECT Remote Basic	GENNECT Remote Pro
Number of available channels per measurement device	30	100
Traffic per gateway (shared by accounts)	1 GB	5 GB

- License plans and prices (tax included)

Plan name	GENNECT Remote Basic	GENNECT Remote Pro
Subscription (monthly)	5,500 yen	11,000 yen
One-month license card	SF4111-01 10,000 yen	SF4112-01 20,000 yen
Three-month license card	SF4111-03 28,000 yen	SF4112-03 56,000 yen
12-month license card	SF4111-12 99,000 yen	SF4112-12 198,000 yen
Additional traffic (1 GB per month)	1,500 yen	1,500 yen

- Starter set

Model name	SF4111	SF4112

GENNECT Cloud Service Specifications

Supported plan name		GENNECT Remote Basic	GENNECT Remote Pro
Product name		Remote measurement service (starter set)	Remote measurement service (starter set)
Price (tax included)		122,000 yen	152,000 yen
Accessories	Gateway	✓ (Z4100)	✓ (Z4100)
	AC adapter	✓	✓
	SIM card	✓ (Z4111) Embedded in the gateway when it is shipped	✓ (Z4112) Embedded in the gateway when it is shipped
	SD memory card	-	✓ (Z4003)
	Registration code	✓	✓
	Instruction manual	✓ SF4111, SF4112 Quick Start Manual SF4111, SF4112 Instruction Manual Z4100 Instruction Manual	✓ SF4111, SF4112 Quick Start Manual SF4111, SF4112 Instruction Manual Z4100 Instruction Manual
	LAN cable (straight) CAT 6a 1 m	✓	✓
	Provided license	One-month Basic license	One-month Pro license

Sample applications/orders

Sample application/order (1)

If you want the following remote measurement at the first application

Number of remote measurement areas	Number of measurement devices to connect	Increase of storage	Traffic	Service period
1	1	100 MB/month	120 MB/month	Automatic renewal

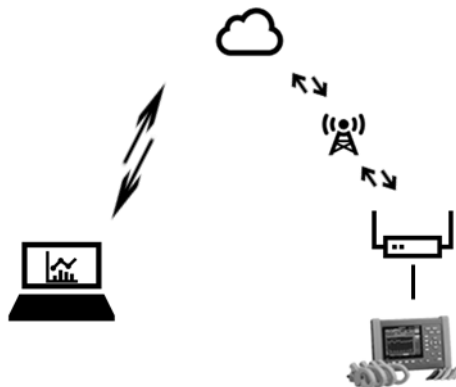

*The maximum number of available channels per measurement device is 30 for the SF4111 and 100 for the SF4112.

Initial product order	
- SF4111 remote measurement service, starter set (with one-month GENNECT Remote Basic license).....	1

By concluding a subscription contract after registration, the service period will be automatically renewed.

Subscription contract	
- Monthly GENNECT Remote Basic contract	1

Sample application/order (2)

If you want the following remote measurement at the first application

Number of remote measurement areas	Number of measurement devices to connect	Increase of storage	Traffic	Service period
1	1	100 MB/month	120 MB/month	Four months

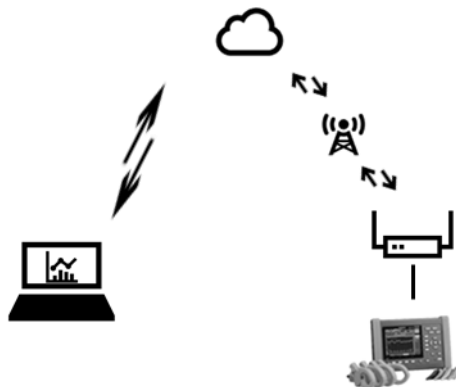

*The maximum number of available channels per measurement device is 30 for the SF4111 and 100 for the SF4112.

Initial product order	
- SF4111 remote measurement service, starter set (with one-month GENNECT Remote Basic license).....	1
- SF4111-03 remote measurement service GENNECT Remote Basic, three-month license.....	1

If you want the following remote measurement at the time of renewal

Number of remote measurement areas	Number of measurement devices to connect	Increase of storage	Traffic	Service period
1	1	100 MB/month	120 MB/month	Six months

Product order at the time of renewal (at the end of the service period above)	
- SF4111-03 remote measurement service GENNECT Remote Basic, three-month license.....	2

Sample application/order (3)

If you want the following remote measurement at the first application

Number of remote measurement areas	Number of measurement devices to connect	Increase of storage	Traffic	Service period
1	3	3 GB/month	3.5 GB/month	13 months

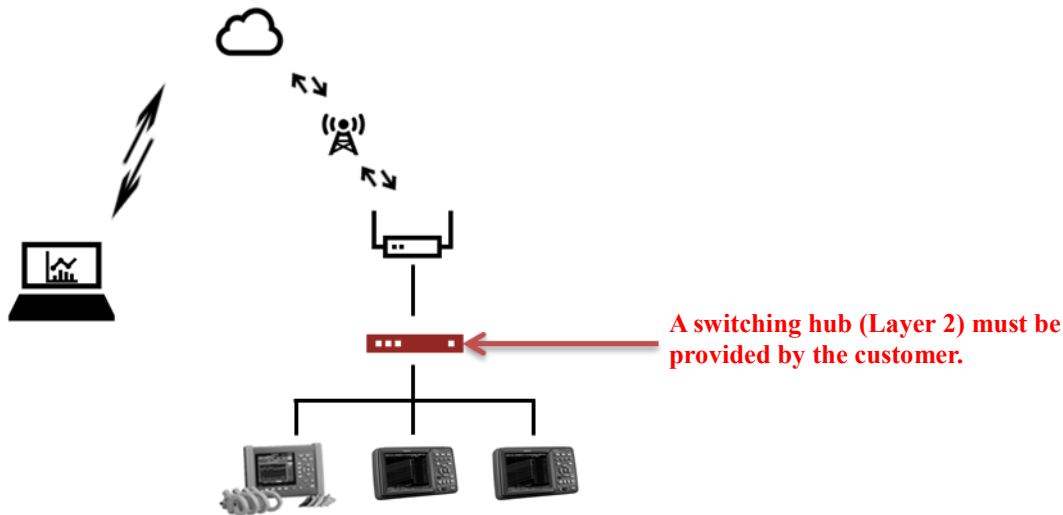

*The amount of data that can be stored in the cloud is 5 GB for Cloud Free, 50 GB for Cloud Standard, and 500 GB for Cloud Pro. If an increase in storage per month is 3 GB, as in the sample order (3), Cloud Standard is required to store 39 GB of data accumulated for 13 months. (No separate application is required because the Cloud Standard service is included in the GENNECT Remote license.)

*The traffic that can be sent from the gateway is 1 GB for Remote Basic and 5 GB for Remote Pro. If the gateway needs 3 GB of traffic, Remote Pro is required.

*The maximum number of available channels per measurement device is 30 for the SF4111 and 100 for the SF4112. If you have three measurement devices, the maximum number of available channels is 90 for the SF4111 and 300 for the SF4112.

Initial product order	
- SF4112 remote measurement service, starter set (with one-month GENNECT Remote Pro license).....	1
- SF4112-12 remote measurement service GENNECT Remote Pro, 12-month license.....	1

If you want the following remote measurement at the time of renewal

Number of remote measurement areas	Number of measurement devices to connect	Increase of storage	Traffic	Service period
1	3	3 GB/month	3.5 GB/month	12 months

*Cloud Pro is required to store 75 GB of data accumulated for 25 months.

Product order at the time of renewal (at the end of the service period above)	
- SF4112-12 remote measurement service GENNECT Remote Pro, 12-month license.....	1
- SF4182-12 measurement cloud service GENNECT Cloud Pro, 12-month license.....	1

Sample application/order (4)

If you want the following remote measurement at the first application

Number of remote measurement areas	Number of measurement devices to connect	Increase of storage	Traffic	Service period
1 (Tokyo)	3	3 GB/month	3.5 GB/month	Automatic renewal
1 (Osaka)	1	1 GB/month	1 GB/month	Automatic renewal

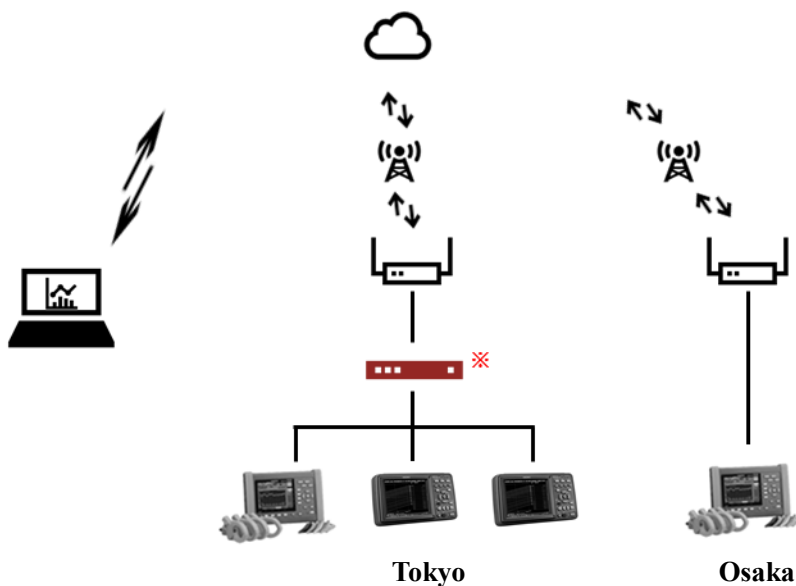

***A switching hub (Layer 2) must be provided by the customer.**

*The amount of data that can be stored in the cloud is 5 GB for Cloud Free, 50 GB for Cloud Standard, and 500 GB for Cloud Pro. If an increase in storage per month is 4 GB, as in the sample order (4), Cloud Standard is required to use the measurement service for 12 months, and Cloud Pro is required to use it for 13 months or more.

*The traffic that can be sent from the gateway is 1 GB for Remote Basic and 5 GB for Remote Pro. If the gateway needs 3.5 GB of traffic, Remote Pro is required.

*The maximum number of available channels per measurement device is 30 for the SF4111 and 100 for the SF4112. If you have four measurement devices, the maximum number of available channels is 120 for the SF4111 and 400 for the SF4112.

Initial product order	
- SF4111 remote measurement service, starter set (with one-month GENNECT Remote Basic license).....	1
- SF4112 remote measurement service, starter set (with one-month GENNECT Remote Pro license).....	1

By concluding a subscription contract after registration, the service period will be automatically renewed.

Subscription contract	
- GENNECT Remote Basic contract	1
- GENNECT Remote Pro contract	1

Sample application/order (5)

If you want the following remote measurement at the first application

Number of measurement areas	Number of measurement devices to connect	Increase of storage	Traffic	Service period
1	3	500 MB/month	-	6 months

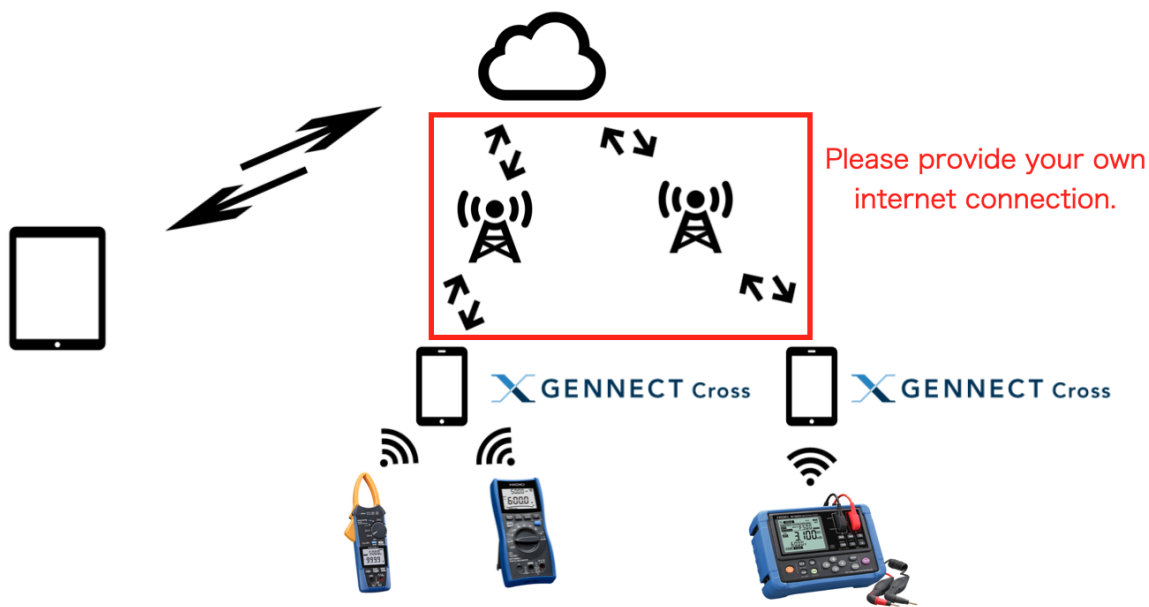

*GENNECT Cloud Free (free of charge) is available for up to 3 registered applications and up to 3 measuring instruments connected to one application.

*The maximum amount of data that can be stored in the cloud is 5 GB for GENNECT Cloud Free.

*Please provide your own internet connection.

Initial product order
None

If you want the following remote measurement at the time of renewal

Number of measurement areas	Number of measurement devices to connect	Increase of storage	Traffic	Service period
1	3	500 MB/month	-	12 months

*GENNECT Cloud Standard is required to store a total of 18 months' worth of data (500 MB * 18 ≈ 9 GB).

Product order at the time of renewal (at the end of the service period above)
- SF4181-12 GENNECT Cloud Standard..... 1

Sample application/order (6)

If you want the following remote measurement at the first application

Number of measurement areas	Number of measurement devices to connect	Increase of storage	Traffic	Service period
1 (Tokyo)	2	3 GB/month	-	Automatic renewal
1 (New York)	1	2 GB/month	-	Automatic renewal

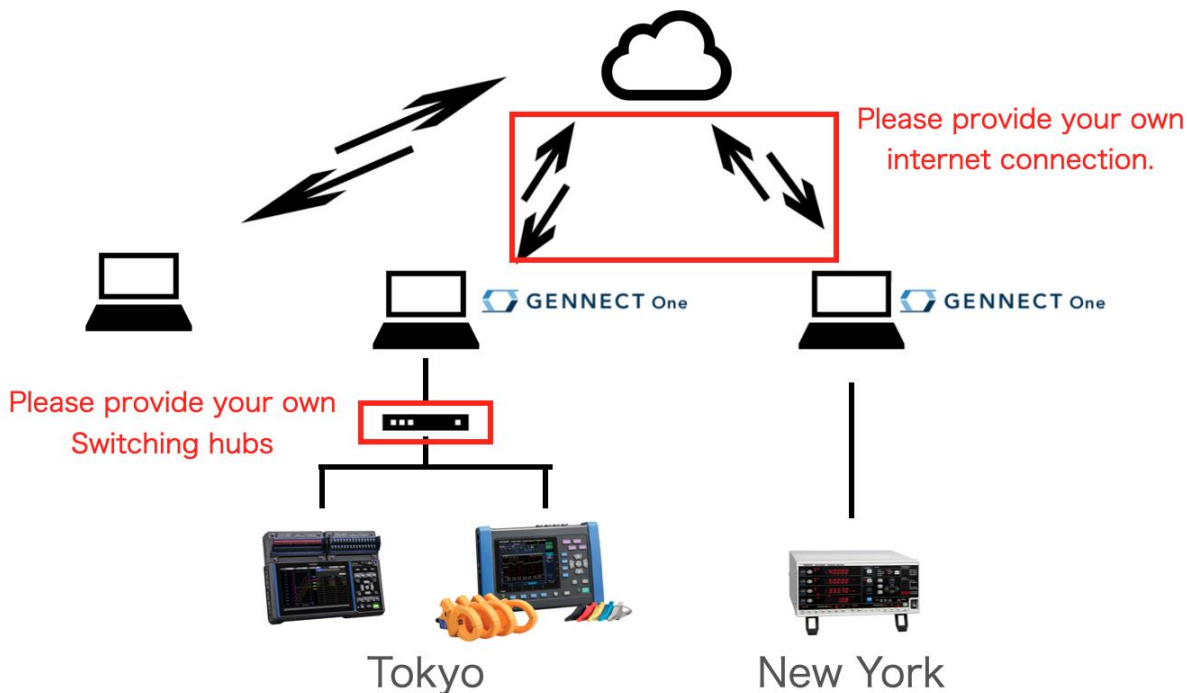

*The amount of data that can be stored in the cloud is 5 GB for Cloud Free, 50 GB for Cloud Standard, and 500 GB for Cloud Pro. If an increase in storage per month is 5 GB, as in the sample order (6), Cloud Standard is required to use the measurement service for 10 months, and Cloud Pro is required to use it for 11 months or more.

*Cloud Free / Cloud Standard: maximum 30 channels per instrument, Cloud Pro: maximum 100 channels.

*Please provide your own internet connection.

Initial product order	
- SF4181 GENNECT Cloud Standard.....	1
or	
- SF4182 GENNECT Cloud Pro.....	1

By concluding a subscription contract after registration, the service period will be automatically renewed.

Subscription contract	
- GENNECT Cloud Standard contract	1
or	
- GENNECT Cloud Pro contract	1

Service features and overview

This chapter provides an overview of the specifications. For detailed specifications, please see the online help.

Functional specifications of the GENNECT Cloud service

-1. Common features

Web screen, Web API	Unless otherwise noted, features are provided both on the Web screen and via the Web API.	
Display language	Describes in “Supported countries”	
Time zone	The time zone displayed on the web page is the time zone set on the viewing terminal (PC/mobile etc.).	
License expiration	<p>In the case of subscriptions, the license term is one month based on the date of activation. The license period is automatically extended every month if the subscription is not cancelled.</p> <p>In the case of a license card, the license expires on the date of registration or the date of the current license plus the number of days on the license card. However, licenses longer than 13 months cannot be set.</p> <p>The date is determined by the time zone as Coordinated Universal Time.</p>	
Log in to the Web page	<p>Log in with the account ID, user ID, and password.</p> <p>Log in with the alternative account ID, user ID, and password (only Cloud Pro).</p> <p>Trial: Log in with the email address and password.</p>	
Obtain the authentication token for the Web API	<p>Only Cloud Pro</p> <p>Obtain the authentication token with the account ID, user ID, and password.</p> <p>Obtain the token with the alternative account ID, user ID, and password.</p>	
Two-factor authentication	None (default)/email/authentication app	
Reset a password	An email containing a password reset URL is sent to the specified email address. A new password can be set on the screen displayed from the URL.	
	Reset URL validity period	30 minutes from transmission

-2. General Features

Common features	<p>Select a measurement group</p> <p>Display/update login user information</p> <p>Logout</p> <p>Automatic logout: The user is automatically logged out after 24 hours of inactivity.</p>
-----------------	--

<p>Monitor features</p>	<p>Monitoring display of the gateway / application / devices / channels / camera images Update interval: 1 minute Time-series viewer Export GENNECT polled data: ZIP (CSV) / HOK / HOK2 Gateway / application self-check Fast monitor mode: 5 seconds (best effort) for 10 minutes (data is logged every minute). Select a Wireless Logger device Select a GENNECT polled channel Number of GENNECT polled channels per measurement device: GENNECT Remote Basic: 30 GENNECT Remote Pro: 100. GENNECT One (Using GENNECT Cloud Trial): 10 GENNECT One (Using GENNECT Cloud Free): 30 GENNECT One (Using GENNECT Cloud Standard): 30 GENNECT One (Using GENNECT Cloud Pro): 100 Change measurement group settings Change gateway settings Change application settings Change measurement device settings Change camera settings Change GENNECT polled channel settings Create dashboard panel Update firmware of instruments</p>
<p>Drive features</p>	<p>List drive details List GENNECT polled data/camera images/files Time-series viewer. Export GENNECT polled data: ZIP (CSV) / HOK / HOK2 File export: ZIP / HOK Publish download URL Open files with viewer Upload arbitrary files Upload HOK files Upload instrument data files Create folder Move folder Delete GENNECT polled data / camera images / files / folders Import of GENNECT polled data HOK file viewer File sorting Cloud storage capacity: GENNECT Cloud Trial: 500 MB GENNECT Cloud Free: 5 GB GENNECT Cloud Standard: 50 GB GENNECT Cloud Pro: 500 GB Available traffic: GENNECT Remote Basic: 1 GB (per gateway) GENNECT Remote Pro: 5 GB (per gateway) Additional traffic</p>

<p>Console features</p>	<p>Remote operation via a Web browser Number of simultaneous accesses: One user for each measurement device Restart the measurement Configure a Wireless Logger device</p>
<p>Alarm features</p>	<p>List alarm settings Create/update GENNECT polled data alarms Alarm conditions: More than, equal to or more than, equal to or less than, less than, out of range (including the threshold), and out of range (not including the threshold). Combined conditions: AND/OR for the conditions of two channels Valid time period: An alarm occurs only within the specified time period Alarm with condition end: ON/OFF Alarm filter: Specifies the duration until the alarm state is changed Enable/disable GENNECT polled data alarms Delete GENNECT polled data alarms Configure file alarms Configure alarm notification language / gateway connect or disconnect / Rest storage of gateway / special value Configure alarm destinations: Email / application / LINE / Slack / Teams Alarm test sending</p>
<p>Time-series viewer features</p>	<p>Select an analysis feature: Graph display, list display, export maximum simultaneous graph display channels, total number of cameras: 32 maximum number of simultaneously listed channels: 32 maximum number of simultaneously exported channels: 32 Export format: ZIP (CSV) / HOK / HOK2 Configure the vertical axis of the graphs Configure vertical axes of a graph in a batch Comparative Graph Display</p>
<p>Notification display features</p>	<p>Show notification list Show the number of unread notifications Filter notification display: Show only unread notifications / Show all Mark specified notifications as read Mark all unread notifications as read</p>
<p>Dashboard features</p>	<p>Panel display(Graph and value / Only graph / Only value / Image and value / Only Image / Alarm) Display update interval: 1 minute Latest value display: displays the latest value of the registered channel Graph display: displays the (last hour's or last day's or last week's) GENNECT polled data for the registered channels Panel display(Picture and value / Only picture) Display update interval: 1 minute Moving the latest value: The latest value displayed can be moved to any location within the image area Edit text display settings Time-series viewer Panel setting change Panel delete</p>
<p>Calculation channel features</p>	<p>Calculation channel list display Create operation channel / Create copy Operators available for operations: + (addition), - (subtraction), * (multiplication), / (division) Functions available for operations: SQ (square), SQR (square root) Number of channels used for operations: between 1 and 10 channels Change of calculation channel settings</p>

	Deletion of operation channels
Report features	Report Setting List Display Report Notification Destination Display Manual Creation of Reports Create / Update report settings Enable / Disable report creation Delete Report Setting Report Notification Destination Settings

-3. Account management features

Account management features	Create account Show/configure account information Show/configure contractor information Create Trial user Trial users expire 93 days after creation After the expiry date, all data is erased and login is no longer possible Upgrade from Trial user to Free user
License management features	Confirm the plan Register a credit card Account subscription contract Gateway subscription contract Cancel subscription Show payment history Download a receipt Register account license card Register gateway license card Plan change (Only once a month) List gateways Register gateway Delete all files in the gateway Setting additional traffic limits
Measurement group management features	Create a measurement group List measurement groups Show the measurement group details Configure the measurement group Delete the measurement group
User management features	Create a user List users Show user details Configure the user Configure two-factor user authentication Delete the user
Team management features	Create a team List teams Show team details Configure the team Delete the team.
System notification management features	Configure notification destinations: Email / application / LINE / Slack / Teams

Inquiry features	Inquiry types: Inquiry / failure report / investigation request / account deletion Send an enquiry specifying the target gateway, remote control permission, subject and body.
Application management features	List applications
Equipment management feature	Equipment list view Equipment detail display Edit equipment Delete equipment

-4. Server event processing features

Collect/store data	Store uploaded GENNECT polled data in the database.		
Channel calculation	Exec channel calculation based on uploaded GENNECT polled data.		
GENNECT polled data alarm feature	Compare the uploaded GENNECT polled data with alarm conditions and notify if they match.		
File alarm feature	Compare the uploaded file with alarm conditions and notify if they match.		
Issue temporary login URL	Issue the URL for temporary login when reporting an alarm.		
	Valid for	30 minutes	
	Restriction	View only No administrator features can be used	
Gateway status notification	Detect and notify connection/disconnection of the gateway and the remaining storage capacity.		
	Remaining capacity	1 GB or less	
Cloud storage notification	Detect and notify the remaining cloud storage capacity.		
	Remaining capacity	10% or less	
Delete excess data	Report that data that exceeds the limit for the license will be deleted in 31 days. Delete the data in 31 days and report the deletion.		
Subscription notification	Notification timing	When a credit cards is registered When a payment is completed When the subscription is automatically renewed When a payment fails 9:00 7 days before the renewal date 9:00 on the day of renewal	
	Notification details	When a credit card is registered	Last 4 digits of the registered card
		When a payment is completed and when the subscription is automatically renewed	Payment date, payment details, next expiration date
		When a payment fails	Payment date, payment details, action request
	7 days before renewal date On the day of the renewal	Renewal date, payment details	

License notification	Notify when the license expiration is approaching if no subscription is purchased.	
	Notification time	0:00 (UTC)
	Notification schedule	Three months to one month before: Notify once a month (on the first Monday of the month) One month to seven days before: Notify once a week (on Monday) 7 days before, on the day, and next day of renewal: Notify that the license has expired
Communication Volume Notification	Provide notification regarding gateway traffic	
	Notification timing	When 90% of the basic communications volume is exceeded, when the total of the basic and additional communications volume is reached, or when the additional communications volume is charged

-5. Restrictions and network requirements

Expiry date for Trial users.	93 days from creation of Trial user. After the expiry date, login is disabled. GENNECT polled data, camera images and files in cloud storage are deleted.
Retention period for GENNECT polled data	Cloud Free: 1 year Cloud Standard, Pro: No limit (limited by capacity)
Retention period for camera image	Cloud Free: 1 year Cloud Standard, Pro: No limit (limited by capacity)
Retention period for files in cloud storage	Cloud Free: 1 year Cloud Standard, Pro: No limit (limited by capacity)
Handling of GENNECT polled data and measurement device data files that exceed the cloud storage capacity	Notify the contractor that the data limit is exceeded and delete all data in 31 days.
Email reception requirement	Ability to receive emails from “no-reply@mail.gennect.net”
Network requirement for Web apps	HTTPS: The outbound TCP:443 port to cloud.gennect.net and app.gennect.net must be open.
Network requirements for the communication lines used for GENNECT One	HTTPS: The outbound TCP:443 port to cloud.gennect.net and app.gennect.net must be open. MQTTS: The outbound TCP:443 port to iot.cloud.gennect.net must be open. TLS mutual authentication shall be permitted. No TLS decryption must be performed on the route. When permitting by domain specification, it is recommended to use the TLS Server Name Indication (SNI) permission rule. SSH (reception of instrument remote control): The outbound TCP:443 port to cloud-relay.gennect.net must be open.
Network requirements for the communication lines used for GENNECT Cross	HTTPS: The outbound TCP:443 port to cloud.gennect.net and app.gennect.net must be open. MQTTS: The outbound TCP:443 and TCP:8883 port toa314maxk2739k7-ats.iot.ap-northeast-1.amazonaws.com must be open. TLS mutual authentication shall be permitted. No TLS decryption must be performed on the route.

	When permitting by domain specification, it is recommended to use the TLS Server Name Indication (SNI) permission rule.
Network requirements for the communication lines used for LR8450	<p>HTTPS: The outbound TCP:443 port to cloud.gennect.net must be open.</p> <p>MQTTS: The outbound TCP:443 port to iot.cloud.gennect.net must be open.</p> <p>TLS mutual authentication shall be permitted.</p> <p>No TLS decryption must be performed on the route.</p> <p>When permitting by domain specification, it is recommended to use the TLS Server Name Indication (SNI) permission rule.</p> <p>SSH (reception of instrument remote control): The outbound TCP:443 port to cloud-relay.gennect.net must be open</p>

-6. Application features

Sharing battery profile features (Available for GENNECT One / GENNECT Cross)	<p>Profile list retrieval</p> <p>Profile upload</p> <p>Profile download</p> <p>Profile deletion</p>
Sharing battery threshold table features (Available for GENNECT One / GENNECT Cross)	<p>Threshold table list retrieval</p> <p>Threshold table upload</p> <p>Threshold table download</p> <p>Threshold deletion</p>
Sharing template features	<p>Template list retrieval</p> <p>Template upload</p> <p>Template download</p> <p>Template deletion</p>
Sharing equipment list features	<p>Equipment list retrieval</p> <p>Equipment upload</p> <p>Equipment download</p> <p>Equipment edit</p> <p>Equipment deletion</p>

Supported browsers

- Operation-checked browsers (Recommended resolution: PC 1,366 × 768, smartphone 375 × 667 or higher)

OS	Browser	Monitor feature availability	Drive feature availability	Console feature availability
Windows	Google Chrome	✓✓	✓✓	✓✓
	Microsoft Edge (version 79 or later)	✓	✓	✓
	Internet Explorer 11	-	-	-
macOS	Google Chrome	✓	✓	✓
iOS	Safari	✓	✓	✓
Android	Google Chrome	✓	✓	✓

✓✓: operation supported, ✓: operation available

Supported countries

Country where the system operates	Japan
Supported countries	Japan and whole country (Excludes China)
Gateways can be used	Japan
Credit card payments are accepted	Japan and whole country (Excludes China)
Language	Japanese / English / Spanish / French / German / Italian
Time zone	Australian Eastern Standard Time / Australian Central Standard Time / Australian Western Standard Time / Afghanistan Time / Alaska Standard Time / Argentina Time / Bangladesh Standard Time / Brunei Time / Bolivia Time / Brasilia Time / Bhutan Time / Central Africa Time / Cocos Islands Time / Central European Time / China Standard Time / Chamorro Standard Time / Chile Standard Time / Colombia Time / Central Standard Time / Cuba Standard Time / Eastern Africa Time / Ecuador Time / Eastern European Time / Eastern Standard Time / Fiji Time / Gulf Standard Time / Hong Kong Time / Hawaii Standard Time / Indochina Time / Iran Standard Time / Israel Standard Time / India Standard Time / Japan Standard Time / Korea Standard Time / Myanmar Time / Mountain Standard Time / Malaysia Time / Nepal Time / New Zealand Standard Time / Peru Time / Philippine Time / Pakistan Standard Time / Pacific Standard Time / Palau Time / Samoa Standard Time / Coordinated Universal Time / Uruguay Time / West Africa Time / Western European Time / Western Indonesian Time / Eastern Indonesian Time / Central Indonesian Time

Functional specifications of the GENNECT Remote gateway

Cell phone line supported	Automatic line connection and reconnection
Features for measurement devices	Automatic IP address assignment by the DHCP server feature Wired: 192.168.1.101 - 254 Wireless: 192.168.100.101 - 254 Automatic search Check measurement device version Automatic measurement start: ON / OFF Forced time adjustment: ON (specify time) / OFF Automatic configuration of measurement devices Accept remote controls
Features for GENNECT polled data	Select channels Number of GENNECT polled channels per measurement device: GENNECT Remote Basic: 30 GENNECT Remote Pro: 100 Upload GENNECT polled data Accept high-speed monitor mode Back up at disconnection: Latest two weeks

Features for measurement device data files	<p>FTP server FTP client Analyse files Upload measurement device data files: Automatic/manual Size limit of automatic file upload: 128 MB or less Size limit of manual file upload: 1 GB or less File backup period: No limit Automatic file deletion: ON / OFF Accept file deletion</p>
Features for cameras	<p>Automatically recognized Number of connection: 1 (cannot be expanded via a USB hub) Camera image quality: Low/Middle/High Regular upload interval: OFF / ON (specify interval) Support events: Upload camera images in ZIP format for one minute before and after the event(PQA power quality events and Recorder triggers) when it occurs. Back up at disconnection: None</p>
Other features	<p>Automatic firmware upgrade. Accept self-check. LED status display.</p>

Supported versions of measurement devices

Please upgrade to the latest firmware version before use.

Model	Application	Monitor	Drive		Alarm	Console
			GENNECT polled data	File		
LR8410/16	Remote One	V1.43		V1.43	V1.43	-
LR8450/-01	Remote One	V1.50		V1.50	V1.50	V1.50
	LR8450 direct	V2.20		V2.20	V2.20	V2.20
LR8101, LR8102	Remote One	V1.50		V1.50	V1.50	V1.50
LR8512	Remote	V1.42		V1.42	V1.42	V1.42
LR8513	Remote	V1.42		V1.42	V1.42	V1.42
LR8514	Remote	V1.42		V1.42	V1.42	V1.42
LR8515	Remote	V1.42		V1.42	V1.42	V1.42
LR8520	Remote	V1.22		V1.22	V1.22	V1.22
LR8530	Remote	V1.06		V1.06	V1.06	V1.06

GENNECT Cloud Service Specifications

LR8531	Remote	V1.06	V1.06	V1.06	V1.06
LR8532	Remote	V1.06	V1.06	V1.06	V1.06
LR8533	Remote	V1.06	V1.06	V1.06	V1.06
LR8534	Remote	V1.06	V1.06	V1.06	V1.06
LR8536	Remote	V1.06	V1.06	V1.06	V1.06
MR6000/-01	Remote One	V3.11	V3.11	V3.11	V3.11
MR8847A	Remote	V2.03	V2.03*2	V2.03	-
MR8875	Remote	V2.17	V2.17	V2.17	V2.17
PQ3100	Remote One	V2.30	V2.30	V2.30	V2.30
PQ3198	Remote One	V2.00	V2.00*1	V2.00	V2.00
PW3360-10/11	Remote One	V3.21	V3.21	V3.21	V3.21
PW3365	Remote One	V2.10	V2.10	V2.10	V2.10
PW3335	Remote One	V1.11	-	V1.11	V1.11
PW3336/PW3337	Remote One	V1.23	-	V1.23	V1.23
PW3390	One	V2.01	V2.01	V2.01	V2.01
PW6001	One	V3.03	V3.03	V3.03	V3.03
PW8001	One	V1.00	V1.00	V1.00	V1.00
BT5525	One	V1.00	V1.00	V1.00	-
ST5680	One	V1.00	V1.00	V1.00	-
IM3523A	One	V1.02	V1.02	V1.02	-
BT3554-01	One Cross	V1.01	V1.01	V1.01	-
BT3554-50	One Cross	V2.01	V2.01	V2.01	-
CM4142	Cross	V1.01	V1.01	V1.01	-
CM4372	Cross	V1.01	V1.01	V1.01	-

CM4374	Cross	V2.03	V2.03	V2.03	-
CM4376	Cross	V1.03	V1.03	V1.03	-
CM3286-01	Cross	V1.01	V1.01	V1.01	-
CM7291	Cross	V1.03	V1.03	V1.03	-
FT3425	Cross	V1.10	V1.10	V1.10	-
FT4310	Cross	V1.03	V1.03	V1.03	-
IR4054-11	Cross	V1.02	V1.02	V1.02	-
IR4055-11	Cross	V1.03	V1.03	V1.03	-
IR4058-20	Cross	V1.02	V1.02	V1.02	-
CM4001	Cross	V1.02	V1.02	V1.02	-
CM4002	Cross	V1.00	V1.00	V1.00	-
CM4003	Cross	V1.00	V1.00	V1.00	-
FT6031-50	Cross	V1.01	V1.01	V1.01	-
PD3259-50	Cross	V1.00	V1.00	V1.00	-
IR4052-50	Cross	V1.00	V1.00	V1.00	-
FT6380-50	Cross	V1.00	V1.00	V1.00	-
DT4261	Cross	V1.01	V1.01	V1.01	-
CM4371-50	Cross	V1.00	V1.00	V1.00	-
CM4373-50	Cross	V1.00	V1.00	V1.00	-
CM4375-50	Cross	V1.00	V1.00	V1.00	-
CM4141-50	Cross	V1.00	V1.00	V1.00	-
CM3286-50	Cross	V1.00	V1.00	V1.00	-

*1 Files on the day cannot be obtained. (They can be obtained by stopping the measurement.)

*2 File transfer once a day and at measurement restart

Maintenance products

The following products are available for maintenance.

Gateway Z4100 and the SIM cards Z4111 and Z4112 cannot be repaired. In the event of a failure, they can be replaced with new ones for a fee. To request replacement, please contact your purchasing dealer (distributor) or nearest sales office.

(Contact: 0268-28-1688 / cs-info@hioki.co.jp)

Model name	Z4100	Z4111	Z4112
Product name	Gateway	SIM card	
Accessories	Gateway	✓	—
	AC adapter	✓	—
	SIM card	—	✓

	SD memory card	—	—	
	Registration code	—	✓	
	Instruction manual	✓ Z4100 Instruction Manual SF4111, SF4112 Quick Start Manual	✓ Z4111, Z4112 Instruction Manual	
		SF4111, SF4112 Instruction Manual		
	LAN cable (straight) CAT 6a 1 m	✓	—	
	Provided license	-	One-month GENNECT Remote Basic license	One-month GENNECT Remote Pro license
Remarks		Replacement when the gateway fails. Remote measurement service is not available with this product alone.	You can use it when you want to resume the remote measurement service after it is finished.	

Service period

Checking the license term

After you log in to the Web service of the Company, you can check the license term by clicking the License Management menu. For details, please see the online help.

Service renewal

When you want automatic service renewal

You can use your credit card for automatic service renewal. Register your credit card and select a plan to sign up for a subscription. When you sign up for a subscription, the license expires one month after the contract date. The subscription will be automatically renewed after one month.

When you want to use a license card for service renewal

You can extend the license term by purchasing a license card for GENNECT Cloud Standard (SF4181-01, -03, or -12), for GENNECT Cloud Pro (SF4182-01, -03, or -12), for GENNECT Remote Basic (SF4111-01, -03, or -12) or for GENNECT Remote Pro (SF4112-01, -03, or -12) and specifying your account and gateway. We recommend that you place your order well in advance because many features will be limited after the license end date.

Sample product order at renewal
- SF4112-12 remote measurement service GENNECT Remote Pro, 12-month license as many as required
- SF4182-12 measurement cloud service GENNECT Cloud Pro, 12-month license as many as required

When you do not want service renewal

- When you do not want to renew GENNECT Cloud
 If you have a subscription contract (Standard or Pro) that uses your credit card, you must cancel it. Please see the online help to complete the cancellation procedure. If you cancel your subscription, you will be moved to the Free plan on the license

expiration date. If you use a license card, no cancellation procedure is required. You will automatically be moved to the Free plan on the license expiration date. In the Free plan, your storage capacity is 5 GB. If your data exceeds the limit, the contractor will receive an email that indicates the data deletion deadline. If your data exceeds 5 GB after the deadline, all data in the storage will be deleted. Please reduce the size of your data before the deadline. Even after you are moved to the Free plan, you can continue to use data and user information if they are smaller than 5 GB. When you ask us to delete your account (GENNECT Cloud > Help > Contact), we will delete your measurement data, account information, and contractor information in the cloud.

- When you do not want to renew GENNECT Remote

If you have a subscription contract (Basic or Pro) that uses your credit card, you must cancel it. Please see the online help to complete the cancellation procedure. If you use a license card, no cancellation procedure is required. After the license end date, communication from the gateway to the cloud will stop. The account is shared with GENNECT Cloud. Please see the previous section for data handling. Data that exists not in cloud storage but in gateway storage on the license end date will not be deleted. However, it cannot be uploaded to the cloud. Please return your SIM card that is no longer necessary to the nearest sales office or the order center in our headquarters.

Service resumption

GENNECT Cloud account

Your GENNECT Cloud account is automatically moved to the Free plan when your license expires. Your account will not be deleted unless the subscriber requests deletion, but each data will be retained for one year.

Resuming the GENNECT Remote gateway (within 31 days after the license term ends)

Service resumption can be conducted with your gateway and SIM card by signing up for a subscription or registering a license card for the gateway within 31 days after the license term ends. Measurement data until the end of the license term is retained. No data will be stored from the end of the license term to the resumption date because communication is suspended during the period. After 31 days, you can still use your gateway, but you must replace your SIM card (Z4111 or Z4112).

Sample product order at resumption (when you can conduct the resumption procedure within 31 days after the license term ends)
- SF4112-12 remote measurement service GENNECT Remote Pro, 12-month license as many as required

Resuming the GENNECT Remote gateway (after 32 days after the license term ends)

After 31 days from the license expiration date, your gateway registration will be deleted, and your SIM card will be invalid. If you want to resume the service, you can reuse your previous gateway Z4100, but you must replace the SIM card Z4111 or Z4112 and register it again.

Sample product order at resumption (when you cannot conduct the resumption procedure within 31 days after the service ends)
- SF4112-12 remote measurement service GENNECT Remote Pro, 12-month license as many as required
- Z4112 SIM cards as many as the required quantity shown above

Service cancellation during the license term

You can cancel the service during the license term, but no refund is available. After the contractor asks us to delete the account, we will delete the gateway registration, measurement data, and account in the cloud.

Changing plans during the license term

It is possible to change the plan of GENNECT Cloud and GENNECT Remote during the license period. The remaining license period will be changed as follows according to the plan you change. Plans can be changed up to once a month for GENNECT Cloud and once a month for each gateway in GENNECT Remote.

For GENNECT Cloud

Standard plan license term [days] = Pro plan license term [days] x 5, rounded down to the nearest whole number The Standard plan license term is approximately 5 times the Pro plan license term.

However, the maximum term of the license is 13 months; any term exceeding 13 months will be deleted.

For GENNECT Remote

Basic plan license term [days] = Pro plan license term [days] x 2, rounded down to the nearest whole number The Basic plan license term is approximately 2 times the Pro plan license term.

However, the maximum term of the license is 13 months; any term exceeding 13 months will be deleted.

Service level agreement (SLA)

Service hours and availability

<p>Web page/Web API service hours</p>	<p>00:00 to 24:00</p> <p>Exception Inability to service maintenance*1 time is not covered by the SLA. *1 22:30 to 23:30 (UTC)</p>
<p>Availability of the Web page/Web API (henceforth called "availability")</p>	<p>If the availability is 99% or more (service unavailability period during the service hours is 1% or less), no compensation is provided, in principle.</p> <p>Service unavailability period: The period when alive monitoring of the Web screen service is unavailable.</p> <p>Compensation If the availability is less than 99%, the number of days corresponding to the service unavailability period is added to the license term. No compensation is provided to a GENNECT Cloud Trial / Free user.</p> <p>Exception The service unavailability period does not include the unavailability due to an Internet connection failure. The service unavailability period does not include the unavailability during the maintenance time that is announced in advance.</p>
<p>Gateway GENNECT polled data/measurement device data files</p>	<p>00:00 to 24:00</p> <p>Exception Missing data during the maintenance time (22:30 – 23:30 (UTC)) is not covered by the SLA. No compensation is provided to a GENNECT Cloud Trial / Free user.</p> <p>Failure time does not include failures caused by power and communication conditions at the installation site. Failure time does not include the unavailability during the maintenance time that is announced in advance.</p>
<p>Inquiry response</p>	<p>Office hours: 23:30–3:00 and 4:00–8:00 (UTC) weekdays Be sure to use the contact form for inquiries.</p>

Operation monitoring

The Company shall monitor the operation 24 hours a day, 365 days a year (366 days for a leap year). When a failure happens, the Company shall promptly handle it and notify the customers (response time is based on our business hours). The Company maintains an access log, which logs the history of accesses to the portal of the Services. The Company may use the log for maintenance management and for statistical analysis of usage. We may also access the account of a customer to verify that the system is working properly during system maintenance or when we handle a failure. The Company shall not use the access log or account information (including measurement data and measurement files), except for maintenance management and usage/operation checks.

Handling a failure

Handling a failure of the gateway and measurement device

The customer must handle a failure of the gateway and measurement devices at the site. The Services do not include on-site support in the event of a failure. However, the Company is responsible for the maintenance and operation of the firmware of the gateway using communication lines.

Handling a cloud service (Web service) failure for the Services

A cloud service (Web service) failure is reported on the portal of the Services. When a failure happens, the Company shall check the operation of the cloud service infrastructure of the Services related to the features provided by the Company and shall report the availability of the features provided by the Services. When a program of the Company fails, the Company shall handle the failure, including restarting the program. The Company may check the data of our customers when we think that a system failure may cause disadvantages to the Company, our agents, or our customers.

Maintenance

The Services may be suspended for maintenance or other work. In that case, the information will be posted on the portal of the Services. However, the above does not apply to the work that the Company considers urgent.

Password policy

Please set your user administrator's password based on the following policy.

- Length: Shall be at least eight characters.
- Combination: At least one number, uppercase alphabetic character, and lowercase alphabetic character shall be included.

Security

The Company shall conduct the following security management.

(i) Computer virus protection

- Deploy computer virus protection products to check for computer viruses in real time.
- Periodically check and verify the information about upgrades and patch releases of the computer virus protection products used in the Services and apply upgrades and patches.

(ii) Unauthorized access

- Use the firewall feature of the cloud service infrastructure to block access to the Services for purposes other than using the system.
- When a user accesses the portal of the Services, authentication and confirmation are conducted with a user ID and password.
- When the IoT gateway device communicates with the service infrastructure of the Services, authentication and confirmation with a certificate shall be conducted. However, when the IoT Gateway device is connected via a closed communication network, authentication and confirmation with a certificate shall be conducted in communication with the edge of the closed communication network.

(iii) Interception of communications

- The communications of users who use the portal of the Services are encrypted by TLS.
- The communications between the service infrastructure of the Services and the IoT gateway device that performs data communication shall be encrypted by TLS. However, communications between the gateway and the cloud server in remote operation using the console features shall be encrypted by SSH.

(iv) Audit

- Provide a vulnerability assessment by an external organization to check for the vulnerabilities of the system and applications.

Safety Control Standards

The Company shall establish the following Safety Control Standards for Article 25 (Confidentiality) and Article 26 (Protection of Personal Information) (hereinafter collectively called “Confidential Information”) of the Terms of Use for the Services.

- The Company shall limit the equipment and facilities for handling Confidential Information and the storage location of equipment and media that store Confidential Information to the greatest extent possible.
- The Company shall implement the measures of locking the storage location and shall control access to the storage location to prevent unauthorized entry by persons other than those authorized to handle Confidential Information.
- The Company shall limit the number of authorized persons who can access Confidential Information as much as possible and shall restrict access using IDs, passwords, or other means of authentication.
- When receiving a request from the person or their representative (a person authorized by the person or a legal representative, such as a person with parental authority, and the same applies hereinafter) to inquire about, correct, or delete the person’s personal information, the Company shall respond to such a request without delay if the Company thinks it necessary to do so. When the Company responds to such a request or decides not to respond, the person or their representative will be notified of the response/decision without delay.
- If an accident, such as leakage, loss, damage, or falsification of Confidential Information occurs, or if objective circumstances arise that indicate a high probability of such an accident, the Company shall immediately report it to the customer.
- In the case of the preceding item, the Company shall implement the necessary measures to prevent a recurrence at its own responsibility and expense.
- When the Services are finished, the Company shall immediately return all Confidential Information (including duplicates) to the customer or dispose of them as instructed by the customer, and delete the Confidential Information on the Company’s servers to make it unrecoverable.

Backing up data

The Company shall create a backup at the following frequency and store it for the following period. After the contract is terminated, the Company shall be responsible for disposing of the backup.

- Backup frequency: Once a day
- Backup period: Seven days

Restoring data

When data is lost by the Services due to a failure, the Company shall promptly pursue the cause and try to restore the data from the backup mentioned above. However, this does not apply to incidents that are attributable to the agent or the customer.

Deleting data

If the storage capacity of the customer is reduced because of a change in the GENNECT Cloud plan or the end of the license term and the data exceeds the capacity, notification of the data deletion deadline will be sent to the customer’s email address. If the data exceeds even after the deadline, all data in the storage will be deleted. It is the customer’s responsibility to save the data to their PC using the file export feature and delete the data from storage before the deadline. In the case of GENNECT Cloud Free, the retention period for each data is one year, and data generated more than one year ago may be deleted.

Deleting an account

Emails are not received for a long time

If the customer's email address does not receive our emails for two months or more, the account may be deleted (frozen). To ensure that the customer will receive important notices, please be sure that the customer's email address receives emails.

Violation of prohibitions of the Terms of Use

If a violation of a prohibition of the Terms of Use is found and improvement is not seen, the account may be deleted (frozen). Before using the Services, please read the Terms of Use carefully and understand them.